

NEW



MPTBWR Series Single Row Thru Hole Right Angle Walled Latching Pin Headers

4-50 Ways Available

Mates with MH545 Housings

Contact 0.40mm Square Pin

Temperature Range -40°C to +125°C

Insulation Resistance 1,000MΩ

Standard Gold Plated on Contact Area

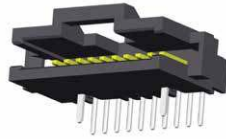

Current Rating 2A AC

Withstanding Voltage 900VRMS

Voltage Rating 300VRMS

PA9T UL 94VO Black

RoHS Compliant



Outline Dimension

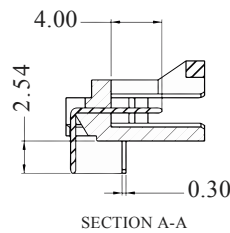
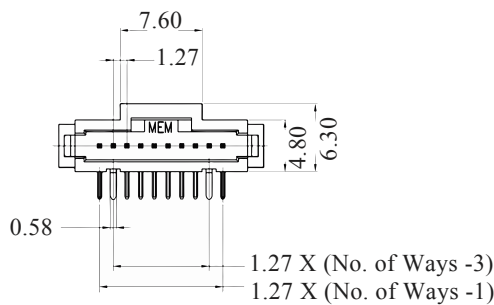
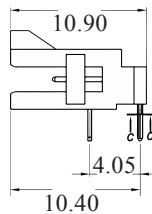
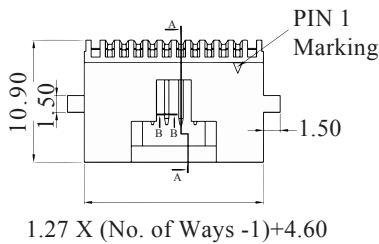

Mating Connector



MH545

Recommended PCB Layout

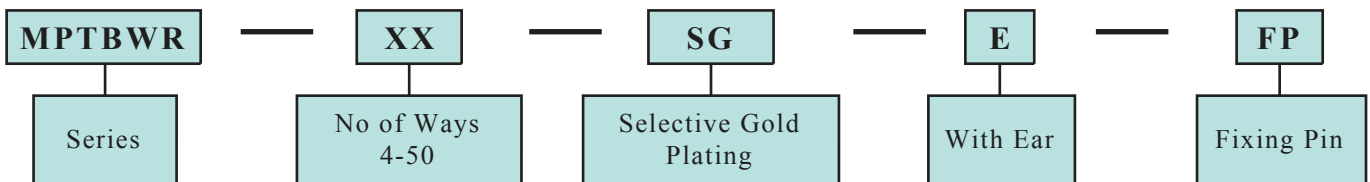
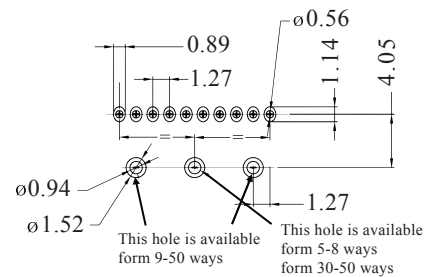

MEMCON (Asia) Limited
Units 5/6 6/F Westley Square
48 Hoi Yuen Rd Kwun Tong Hong Kong
T +852 3741 1411 F +852 3747 8980
www.memcon.asia sales@memcon.asia
GB Issue 1

MEMCON Limited
Unit 8 Campus Five Third Avenue Letchworth
Hertfordshire SG6 2JF United Kingdom
T +44 1462 371477 F +44 1462 677499
www.memcon.eu sales@memcon.eu
MEMCON[®] is a registered trade mark of Memcon Limited

MEMCON North America
6000 Red Arrow Hwy Unit
Stevensville Michigan 49127 USA
T +1 269 281 0478 F +1 269 593 5952
www.memcon.net sales@memcon.net